

Sensor IQ Easy 2.0 EX

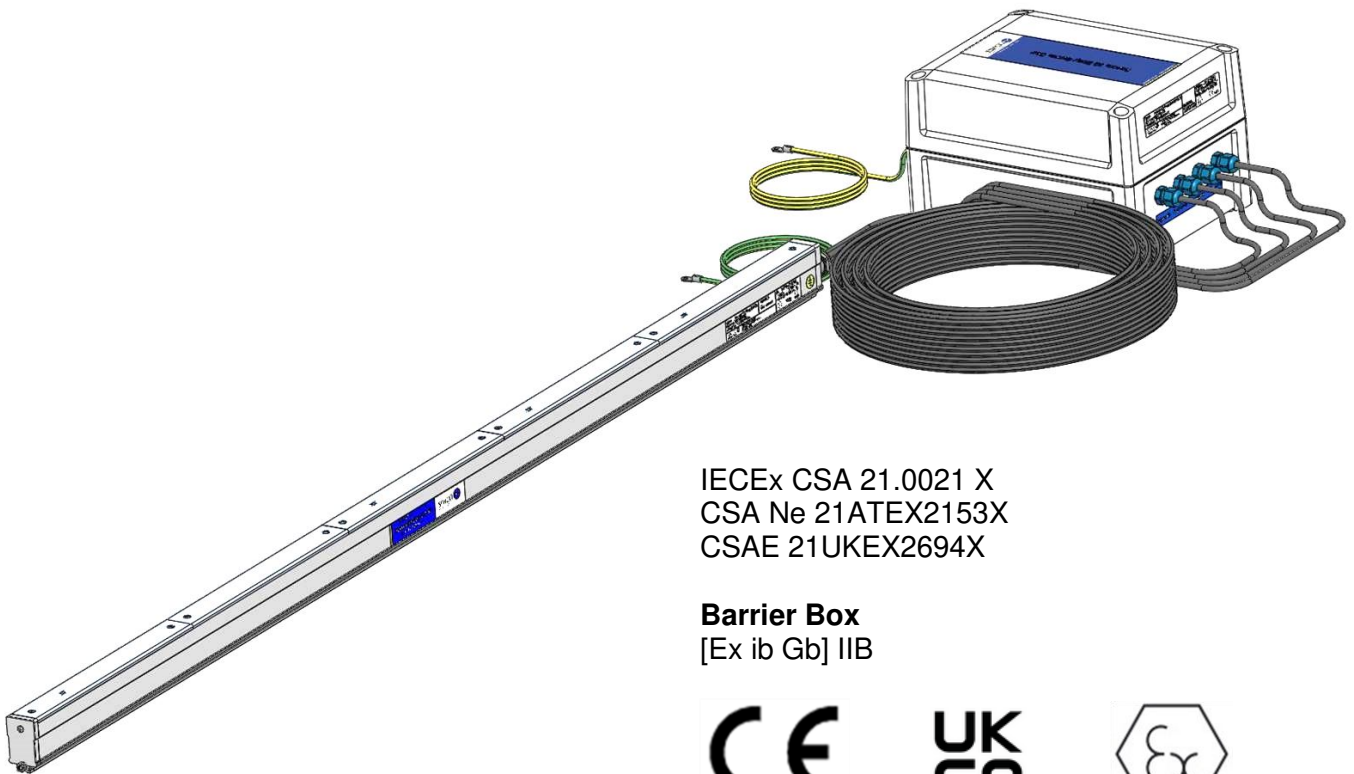

IECEX CSA 21.0021 X
CSA Ne 21ATEX2153X
CSAE 21UKEX2694X

Barrier Box
[Ex ib Gb] IIB



2813



0518



II (2) G

Sensor Bar
Ex ib IIB T4 Gb



2813



0518



II 2 G

IEC 60079-0:2017
IEC 60079-11:2011
EN IEC 60079-0:2018
EN 60079-11:2012

GB User Manual

1

GB

TABLE OF CONTENTS

Preface	4
Explanation of symbols	4
1 Introduction	5
2 Description and operation	6
3 Safety	8
4 Technical specifications	9
5 Installation	11
5.1 Checks	11
5.2 Installing segment units in the Sensor IQ Easy 2.0 EX bar	11
5.3 Shortening the cable(s) between the Barrier Box and a Sensor IQ Easy 2.0 EX bar	11
5.4 Placing the Sensor IQ Easy 2.0 EX	13
5.5 Mounting bracket	14
5.6 Mounting Sensor IQ Easy 2.0 EX (slide bracket)	15
5.7 Dismantling Sensor IQ Easy 2.0 EX (slide bracket)	16
5.8 Connecting the Barrier Box	16
6 Commissioning	17
6.1 Commissioning the Sensor IQ Easy 2.0 EX using the IQ Easy Platform	17
6.2 Selecting EXPERT mode for setting parameters or allowing for maintenance	17
6.3 Selecting mounting distance Sensor IQ Easy 2.0 EX (expert mode)	18
6.4 Set the warning maximum level (expert mode)	18
6.4.1 Set the warning minimum level (expert mode)	19
6.5 Setting the alarm maximum level (expert mode)	19
6.5.1 Set the alarm minimum level (expert mode)	19
6.6 Setting warning/alarm error delay (expert mode)	19
6.7 Sensor IQ Easy 2.0 EX Standby & Active	19
6.8 Setting bar information parameters (expert mode)	20
6.9 (De)activating active segments (expert mode)	20
6.10 (De)activating Datalogging (expert mode)	20
6.11 Switching the bar on/off remotely through the remote on/off input on the manager or using fieldbus (expert mode) (will be implemented in the software later)	20
7 Functional check	21
7.1 Functional check	21
7.2 Functional check via the Manager IQ Easy	21
7.2.1 Information tab.....	21
7.2.2 Graphics tab.....	22
7.2.3 Action log tab.....	22
7.2.4 Data log tab.....	22

8 Maintenance	22
8.1 Cleaning the Sensor IQ Easy 2.0 EX.....	22
9 Faults	23
10 Repairs and calibration	24
11 Disposal.....	24
Spare parts.....	24

Preface

This manual is intended for installation and use of the Sensor IQ Easy 2.0 EX.

This manual must be available at all times to staff operating the equipment.

Read through the entire manual before installing and commissioning the product.

Follow the instructions set out in this manual to ensure proper operation of the product and to retain your entitlement under the guarantee.

The guarantee terms are set out in the General Terms and Conditions of Sale of SIMCO (Nederland) B.V.

Explanation of symbols



Warning

Indicates special information to prevent injury or significant damage to the product or the environment.



Note

Important information for making the most efficient use of the product and/or for preventing damage to the product or the environment.



If there are icons between the [], it may be necessary to first select the icons between [] before you can go to the desired page with follow-up instruction(s).

Using   buttons you can scroll through the various pages.

1 Introduction

The Sensor IQ Easy 2.0 EX is designed for monitoring electrostatic charge. It consists of 2 parts, the Sensor IQ Easy 2.0 EX bar and a Barrier Box. The Sensor IQ Easy 2.0 EX bar itself is constructed to be used in specific explosion hazardous areas, see chapter 3, Safety.



Note:

The Barrier Box should be placed outside the hazardous area!

Up to 8 sensor segments can be placed in a Sensor IQ Easy 2.0 EX. And up to 4 sensor segments can be connected to 1 Barrier Box. The Sensor IQ Easy 2.0 EX will function optimally at a distance of between 10 and 300 mm to the material and is available in lengths of 267 mm to 6017 mm (with max. 8 sensors and max. 2 Barrier Boxes connected). Segments positions are available in increments of 250 mm. And segments could be rotated 180 degrees in there bay, so increments of 125 mm between the measuring elements of 2 segments could be accomplished.

Each sensor segment can be placed at a strategic position above the material web for measuring/monitoring the electrostatic charge. All data from each sensor segments is communicated to the Barrier Box and then communicated to the Manager IQ Easy. In the Manager IQ Easy data can be stored for process monitoring.

Data received from the sensor segments can also be used for quality and process control. The log data can be retrieved from the Manager IQ Easy via the standard Ethernet port or an attached USB flash drive.

The Sensor IQ Easy 2.0 EX gets it power from the Barrier Box and the Barrier Box is supplied with 24 V DC supply voltage from the Manager IQ Easy through a standard 5-pin M12 connector. Also, the Barrier Box is provided with 1 LED for (status, warning and alarm).

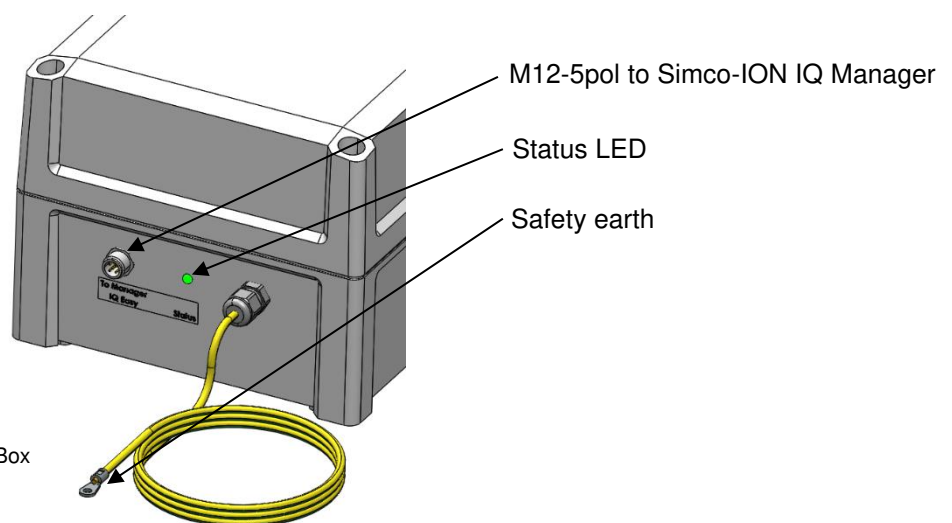

Figure 1: Connecting Simco-ION Barrier Box

2 Description and operation

The Sensor IQ Easy 2.0 EX consists of a bar-shaped aluminium profile. On one or two sides of this profile there are outlets for cables. These cables run to a Barrier Box. The configuration of max. 4 bay's and max. 4 segments connected to 1 Barrier Box could be placed a second time mirrored in the profile to get up to max. 8 bay's and max. 8 segments in one profile. Between the bay's there are dummy's placed that cover up the empty spaces on top of the profile.

Example: Sensor IQ Easy Ex bar for 2 segments, with 1 dummy position

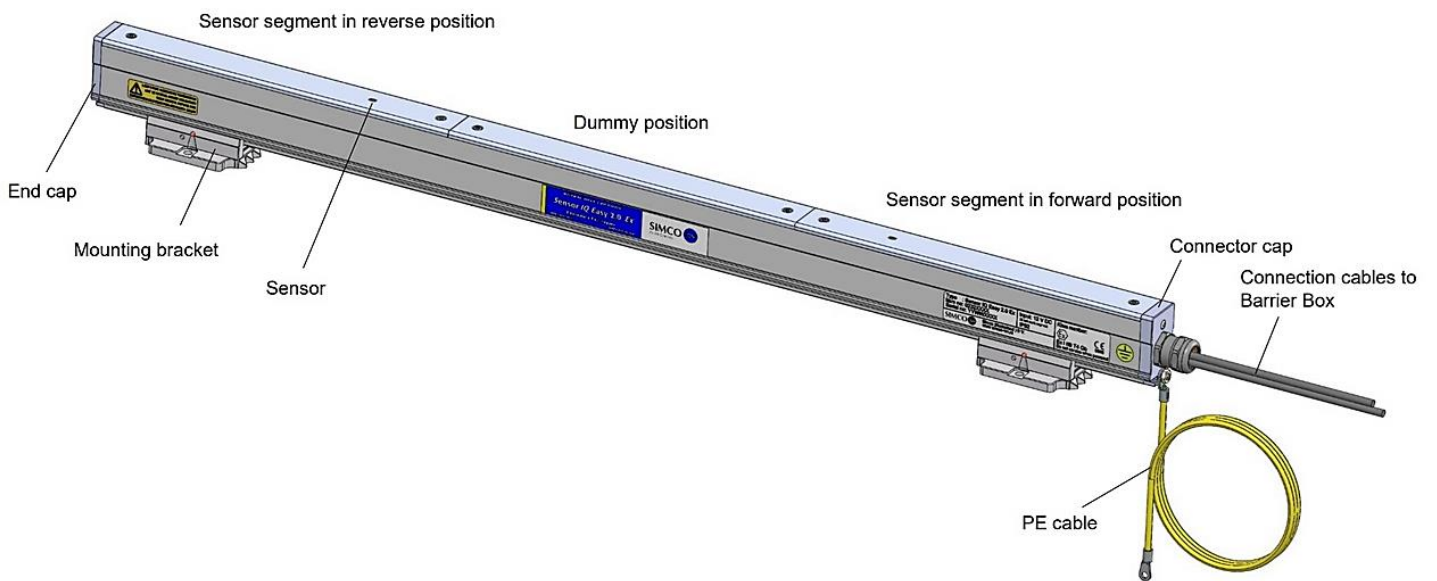

Figure 2: Make-up Sensor IQ Easy 2.0 EX

Configuring the Sensor IQ Easy 2.0 EX is done through the Manager IQ Easy.
All data from each sensor is communicated to the Manager IQ Easy and is stored for process control.



Menu
Sensor IQ
Easy 2.0 EX

Figure 3: Manager IQ Easy



The background colour of the sensor icon displays the status of the Sensor.



Inactive or no communication



Active and operating OK, without warnings or alarms

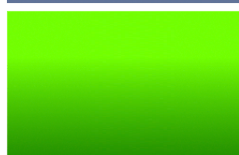

Standby, waiting for start command



Active, but with a warning



Active, but with an alarm

3 Safety

The following safety guidelines must be observed in order to prevent physical injury and damage to objects or to the Sensor IQ Easy 2.0 EX itself.



Warning:

- The Sensor IQ Easy 2.0 EX is designed solely for measuring electrostatic charge.
- The electrical installation and repair must be carried out by an electrical engineer with the relevant training and qualifications and in accordance with the applicable national and local regulations.
- The Sensor IQ Easy 2.0 EX can only be supplied and connected to the Barrier Box.
- Before using the Sensor IQ Easy 2.0 EX in an explosive hazardous area, check whether it is permitted to be used in the zone classification of the hazardous area.
- The Sensor IQ Easy 2.0 EX is suitable for ATEX II 2G.
- The Sensor IQ Easy 2.0 EX should only be used in non-mining applications.
- The Sensor IQ Easy 2.0 EX may be used in gas zones 1 and 2 and is suitable for gas groups IIA and IIB.
- To ensure the safe operation, the working temperature should be kept below 40°C.
- Only the Sensor IQ Easy 2.0 EX should be installed in Ex-zone environments.
- The Barrier Box should NOT be installed in Ex-zone environments.
- Do not clean or open the Sensor IQ Easy 2.0 EX bar or the Barrier Box when an explosive atmosphere is present.
- Do not place or remove segments when an explosive atmosphere is present.
- Do not power up the Sensor IQ Easy 2.0 EX when not all the bay positions have been fitted with a segment or a blanking cover.
- There are no serviceable parts inside the Sensor IQ Easy 2.0 EX or in the Barrier Box.
- Do not expose the Sensor IQ Easy 2.0 EX bar and Barrier Box to mechanic shocks and vibrations.
- Fit all the connecting cables in such a way there is no chance on mechanical damage of the cables.



Note:

Making changes, adjustments etc. without prior written consent or carrying out repairs using non-original parts will invalidate the device's guarantee and could invalidate approvals.

4 Technical specifications

Required power supply

Supply voltage Barrier Box (Un) 21 – 27 VDC
Um 250V

Max. Cable length from a Manager IQ Easy to a Barrier Box 50 meter with min. conductor size 0,34 mm²

Connection Standard industrial M12 5-pin connectors

Cable length from a Barrier Box to a Sensor IQ Easy 2.0 EX Maximum length is 15 meter (This cable(s) could not be self-made and are supplied directly connected to the Sensor IQ Easy 2.0 EX. They can only be shortened by the customer).

Number of segments

Number of segments Max. 4 (1x Barrier Box), Max. 8 (2x Barrier Box)
Number of placeable bay positions Max. 8

Detection Range 0kV to 10kV @ 10mm
0kV to 30kV @ 20mm to 50mm
0kV to 50kV @ >100mm
Lower web voltages charges could be measured best on lower mounting distance and vice versa.

Operating distance 10mm to 300mm

Environment

Use Industrial, indoor use
Density class IP52
Temperature -20°C to 40°C

EX environment

Barrier Box
[Ex ib Gb] IIB



Sensor Bar
Ex ib IIB T4 Gb



Standards

IEC 60079-0:2017
IEC 60079-11:2011
EN IEC 60079-0:2018
EN 60079-11:2012

Local signalling

LED on Barrier Box
 Green, Continuously = In operation
 Green, Flashing = Standby
 Red = Alarm
 Orange = Warning
 See chapter 7 for all indications

Functions (with IQ Easy platform)
 The Sensor can be monitored using the Manager IQ Easy (see also user manual Manager IQ Easy).

Mechanical

Sensor IQ Easy 2.0 EX

Length 267 mm to 6017 mm
 Dimensions without mounting brackets
 Width 30 mm
 Height 52 mm
 including mounting brackets
 Width 50 mm
 Height 70 mm
 Weight 2 kg/m
 Housing material Bare aluminium

Barrier Box

Dimensions
 Width 190 mm
 Height 150 mm
 Length 240 mm
 Weight 3 kg
 Housing material ABS/PC

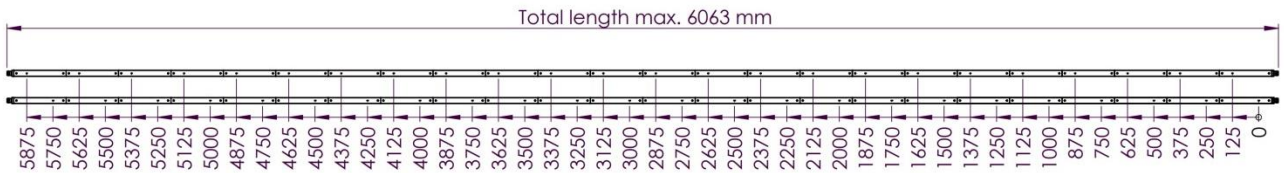

- Max. 4 segments when supplied from 1 side with 1 Barrier box, bar has 1 connector
- Max. 8 segments when supplied from 2 sides with 2 Barrier boxes, bar has 2 connectors, one at each side
- Max. 24 possible segment positions
- Segments can be mounted reversible, which makes 48 possible sensor positions
- Positions without segments are filled with dummy covers

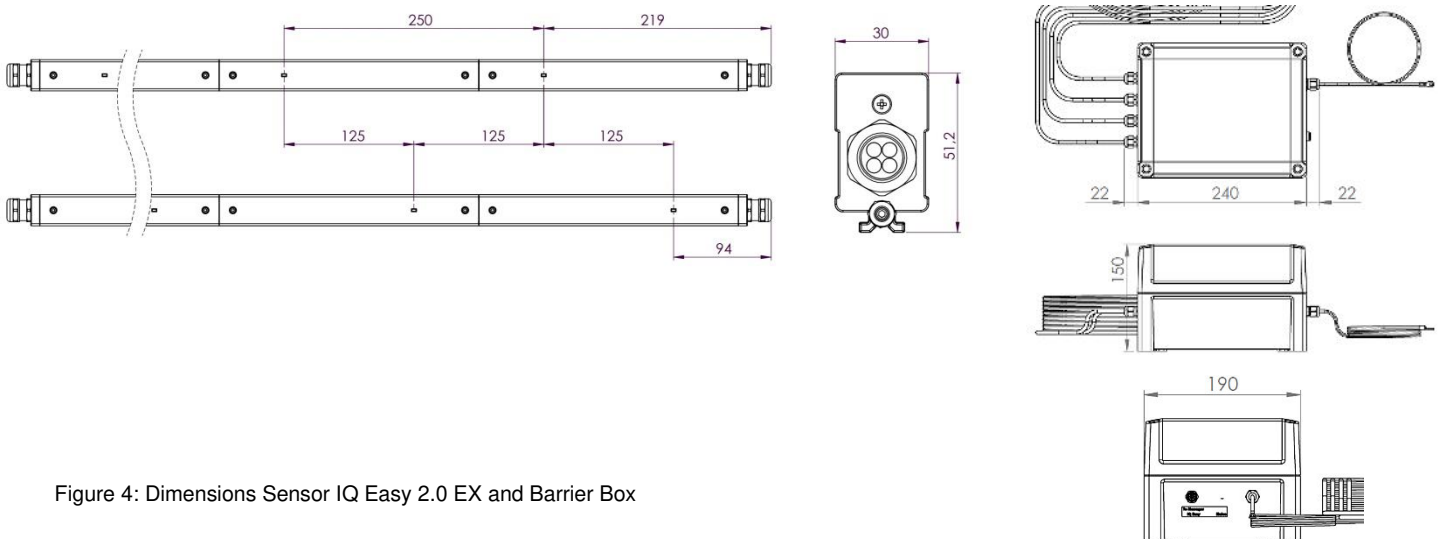

Figure 4: Dimensions Sensor IQ Easy 2.0 EX and Barrier Box

5 Installation



Warning:

- The electrical installation and repair must be carried out by an electrical engineer with the relevant training and qualifications and in accordance with the applicable national and local regulations.
- The equipment must be properly earthed. Earthing is necessary to ensure proper and safe operation in hazardous areas.
- Connect the 4mm² earth cable from the Barrier Box to an infallible earthing system.
- Connect the 4mm² earth cable from the Sensor IQ Easy 2.0 EX bar to an infallible earthing system.
- Disconnect the power supply before carrying out any work on the unit.
- Only the Sensor IQ Easy 2.0 EX bar should be installed in Ex-zone environments.
- Before installing the Sensor IQ Easy 2.0 EX in an explosive hazardous area, check whether it is permitted to be used in the zone classification of the hazardous area.

5.1 Checks

- Check the equipment for damage and whether you have received the correct version. The segment units are supplied in a separate package, because the sensors are very sensitive to falling and bumping.
- Check whether the data on the packing slip corresponds to the data shown on the product received.

If you have any problems or are unsure, please contact Simco-ION or your regional agent.

5.2 Installing segment units in the Sensor IQ Easy 2.0 EX bar

- Remove the segment unit from the packaging.
- Make sure the right DIP switch setting is set for the desired segment number.

Adr	SW1.1	SW1.2	SW1.3	SW1.4
Seg1	On	On	On	On
Seg2	Off	On	On	On
Seg3	On	Off	On	On
Seg4	Off	Off	On	On

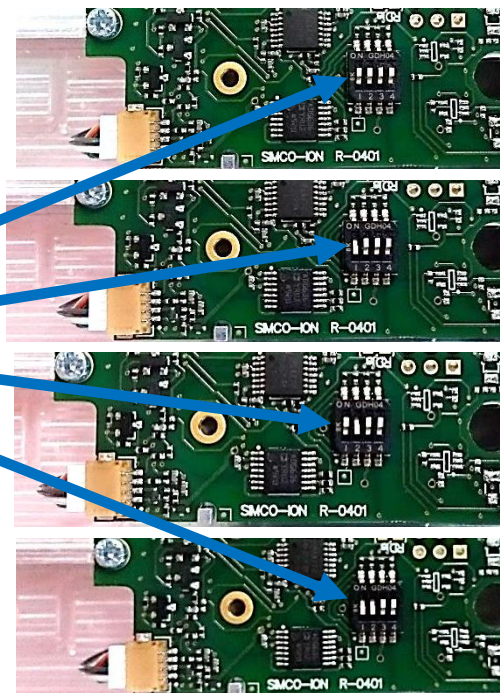

- Place the segment in the desired bay of the Sensor IQ Easy 2.0 EX bar. The segment unit can be fitted both ways in a bay.
- Then tighten the two bolts on the side of the segment unit. Use a small screwdriver, not an electric screwdriver or cordless drill! 

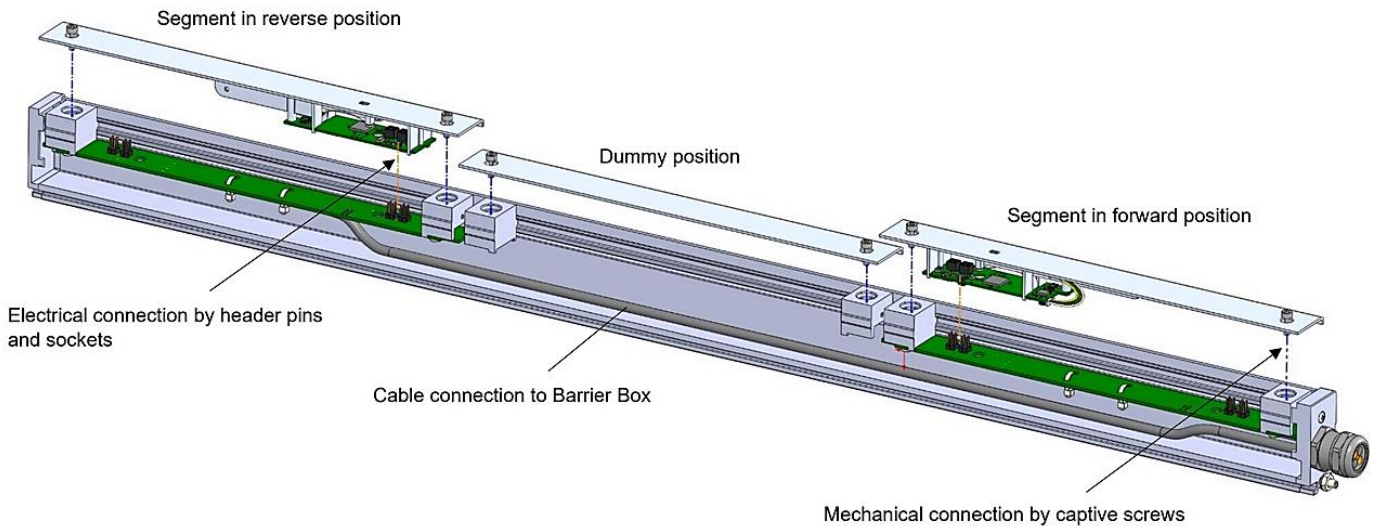
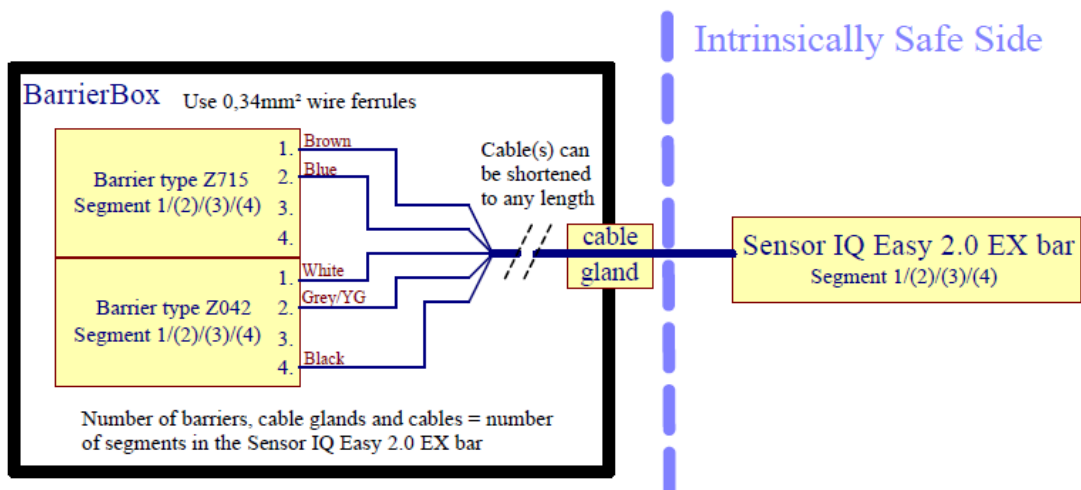



Figure 5: Placing the Segment unit in the docking station

5.3 Shortening the cable(s) between the Barrier Box and a Sensor IQ Easy 2.0 EX bar

The maximum length of the cable(s) between the Barrier Box and the Sensor IQ Easy 2.0 EX is 15 meter. This cable(s) could not be self-made and are supplied directly connected to the Sensor IQ Easy 2.0 EX. They can only be shortened by the customer.



5.4 Placing the Sensor IQ Easy 2.0 EX

 **Note: Conductive machine parts close to an Sensor IQ Easy 2.0 EX may have a negative influence on its effectiveness. For the best results the Sensor IQ Easy 2.0 EX should be mounted according to figure 6.**

Mount the Sensor IQ Easy 2.0 EX:

- With the bar perpendicular in the direction of the material to be measured.
- If applicable behind an anti-static bar. At least 2x the operating distance of the anti-static bar.

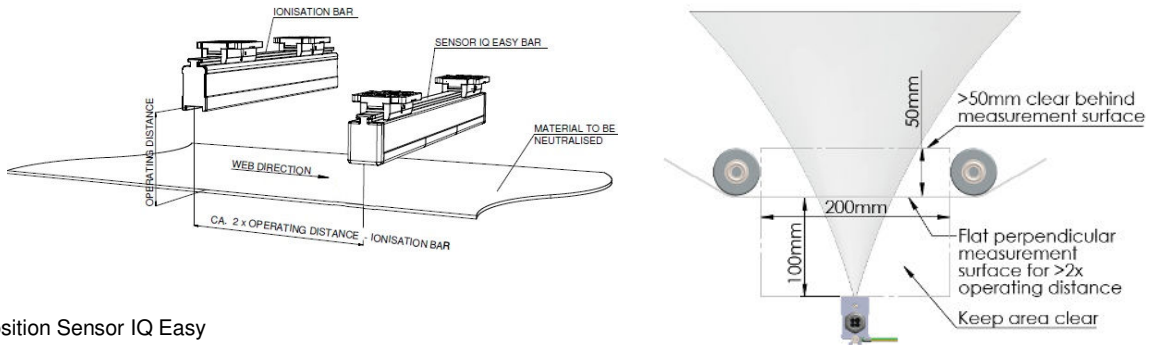

Figure 6: Position Sensor IQ Easy

- The measurement range of the Sensor IQ Easy 2.0 EX could be explained by a combination of 3 factors: the electrostatic web voltage charge, the mounting distance between the measurement surface and the Sensor IQ Easy 2.0 EX and the size of the measuring spot on the measurement surface. Therefore it is important to set the correct mounting distance of the Sensor IQ Easy 2.0 EX in the Manager IQ Easy, see H6.3. And to make sure that measuring spot of the Sensor IQ Easy 2.0 EX on that distance is fully on the surface to be measured. Lower web voltages charges could be measured best on lower mounting distance and vice versa.
- 0kV to 10kV @ 10mm
0kV to 30kV @ 20mm to 50mm
0kV to 50kV @ >100mm

Note:
For segment positions, placements and dimensions see the technical drawings of the Sensor IQ Easy 2.0 EX

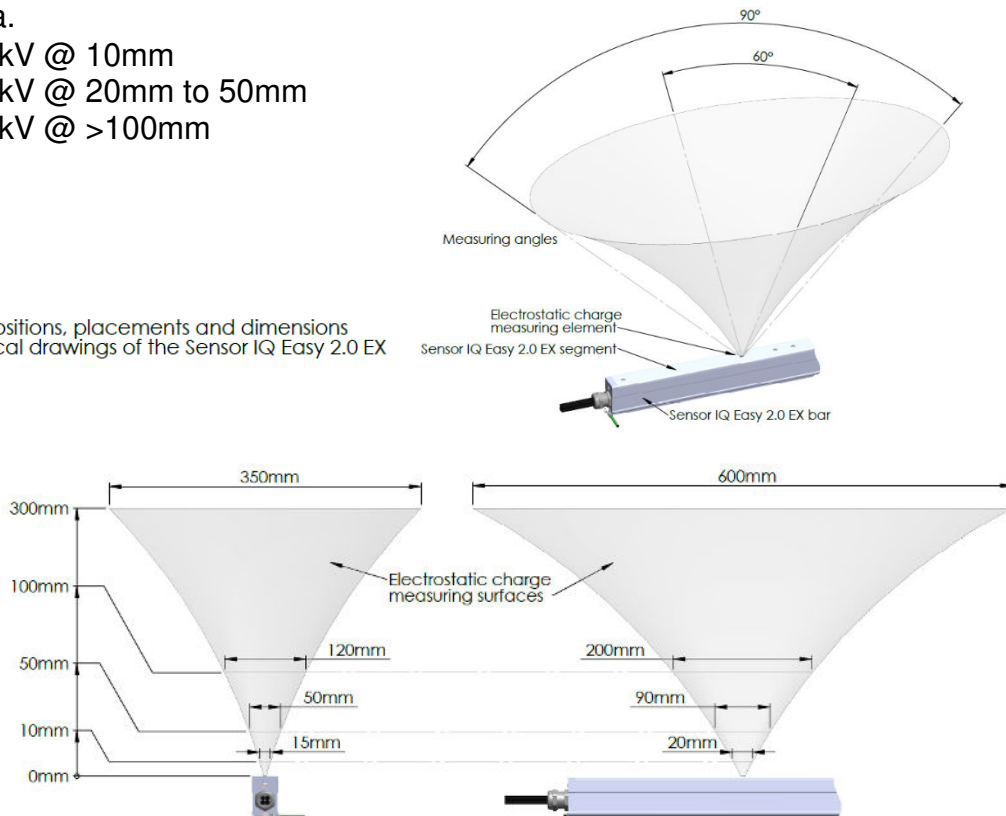

Figure 6b: Visualization measuring angles and distances

5.5 Mounting bracket

The Sensor IQ Easy 2.0 EX bar is supplied with at least two mounting brackets. Which could be used to mount Sensor IQ Easy 2.0 EX in various ways.
The Barrier Box is supplied with 4 mounting brackets.

 **Note: Keep in mind that the plastic mounting brackets are not electrically conductive. Make sure that the Sensor IQ Easy 2.0 EX is properly grounded (see chapter 5).**

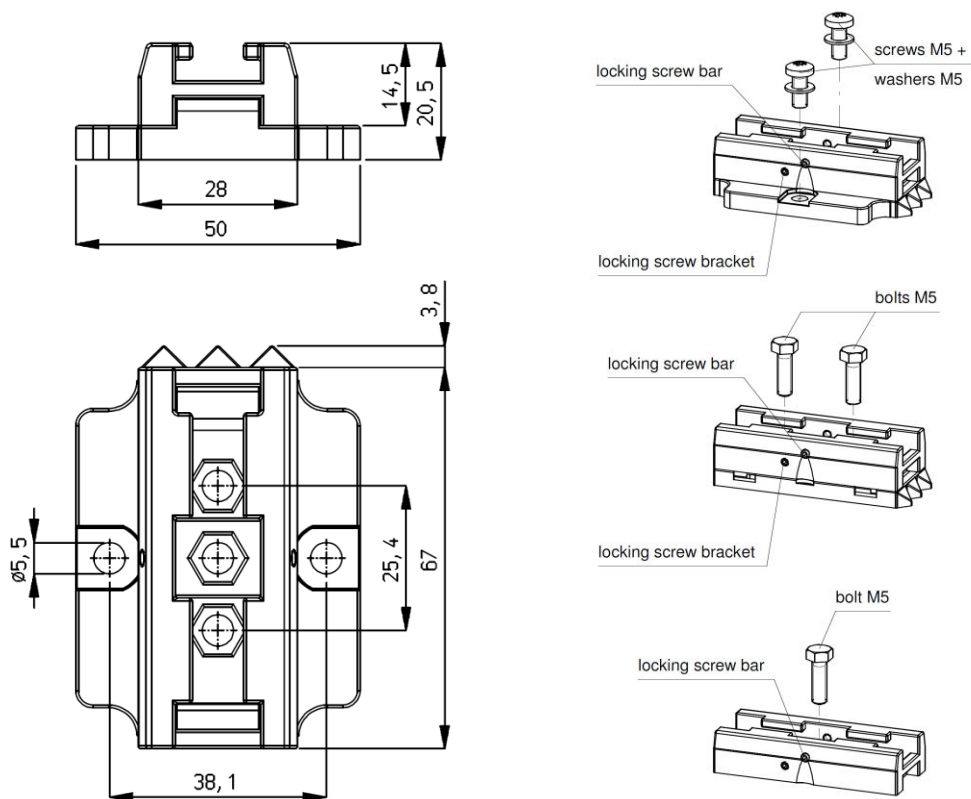

Figure 7a: Dimensions and mounting options for the brackets of the Sensor IQ Easy 2.0 EX bar.

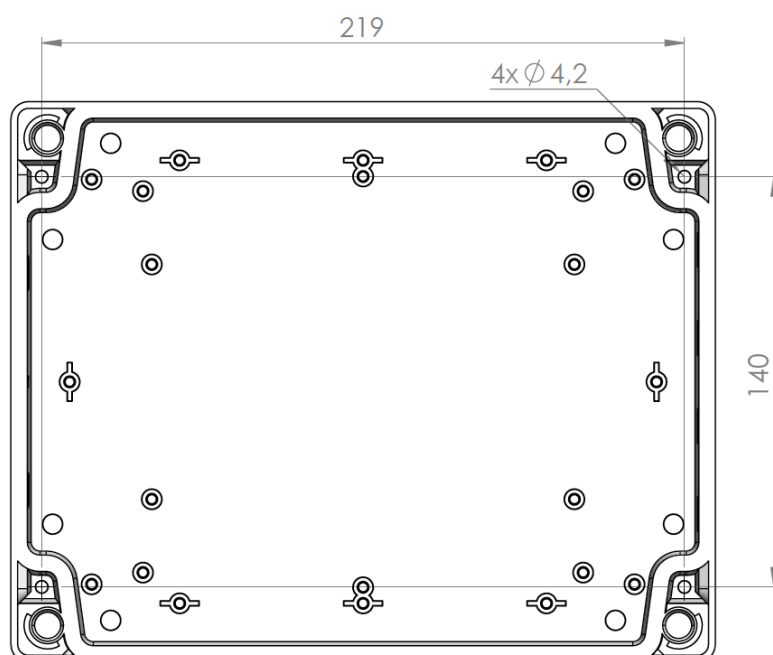

Figure 7b: Dimensions and mounting options for the brackets of the Barrier Box

5.6 Mounting Sensor IQ Easy 2.0 EX (slide bracket)

- Attach the mounting feet (1) on the machine. The triangles (2) have to point in the same direction. For mounting use appropriate M5 mounting material (3).
- Slide the brackets (4) onto the Sensor IQ Easy 2.0 EX (5). Keep spacing of the brackets (4) and mounting foot (1) equal and lock the bracket (2) with the set screw (6).
- Set the Sensor IQ Easy 2.0 EX with brackets onto the mounting feet and slide the combination against the direction of the triangles.
- Lock the Sensor IQ Easy 2.0 EX in the mounting feet by screwing the two adjusting screws (7) into the brackets. With more than two brackets, only the two outer brackets need to be locked.

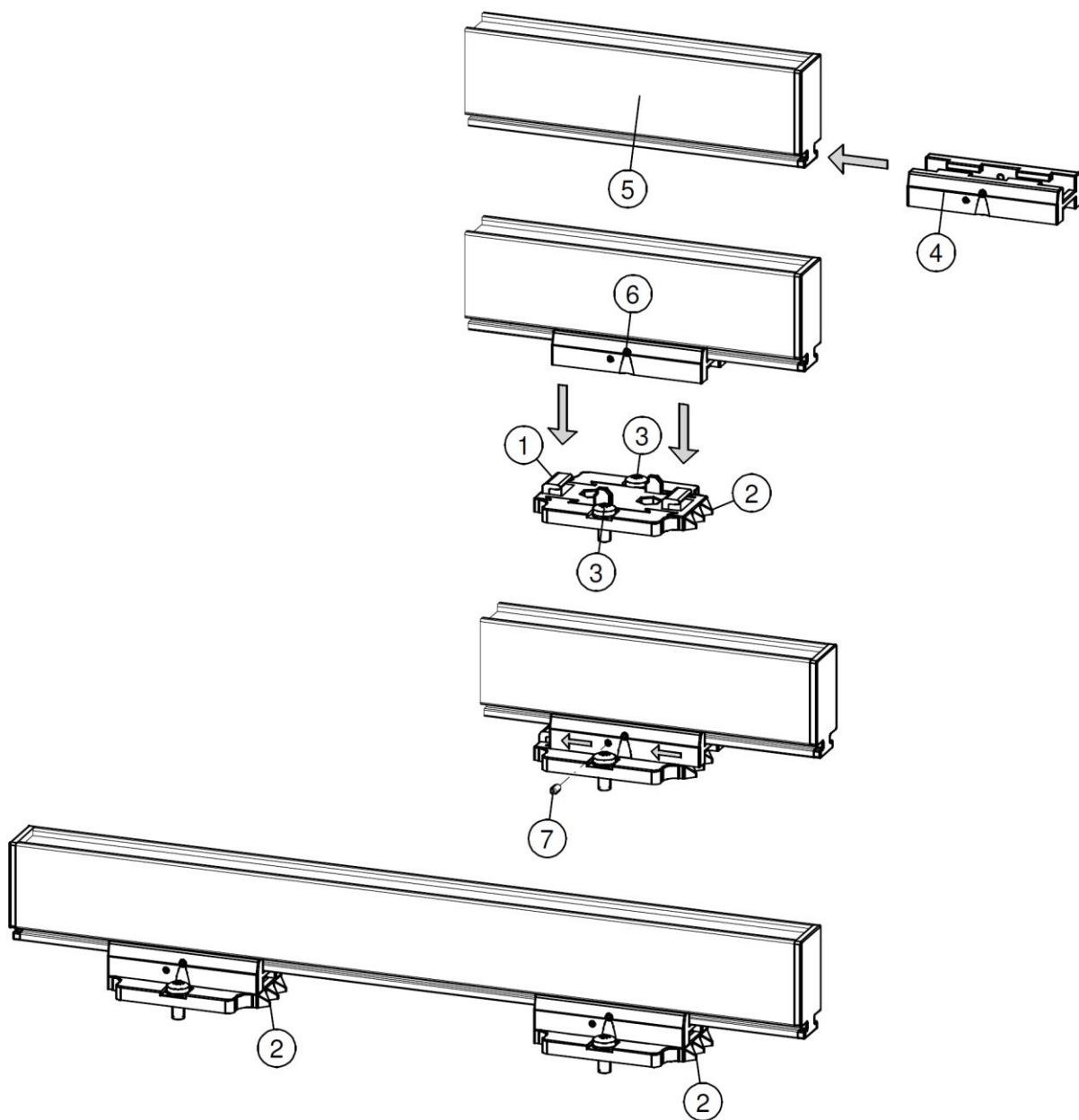

Figure 8: Fixing Sensor with mounting brackets

5.7 Dismantling Sensor IQ Easy 2.0 EX (slide bracket)

- Unscrew the adjusting screws (nr. 7) from the brackets (see figure 8).
- Slide the Sensor IQ Easy 2.0 EX with brackets off the mounting feet, in the direction of the triangles to the stop, then pull the Sensor IQ Easy 2.0 EX from the mounting feet straight up.

5.8 Connecting the Barrier Box

- Connect the Barrier Box to one of the outputs of the Manager IQ Easy, using an 1:1 M12 connection cable, Male-Female, 5 pins.
The standard M12 connector can be connected during operation of the Manager IQ Easy. Hence, it does not need to be powered down.

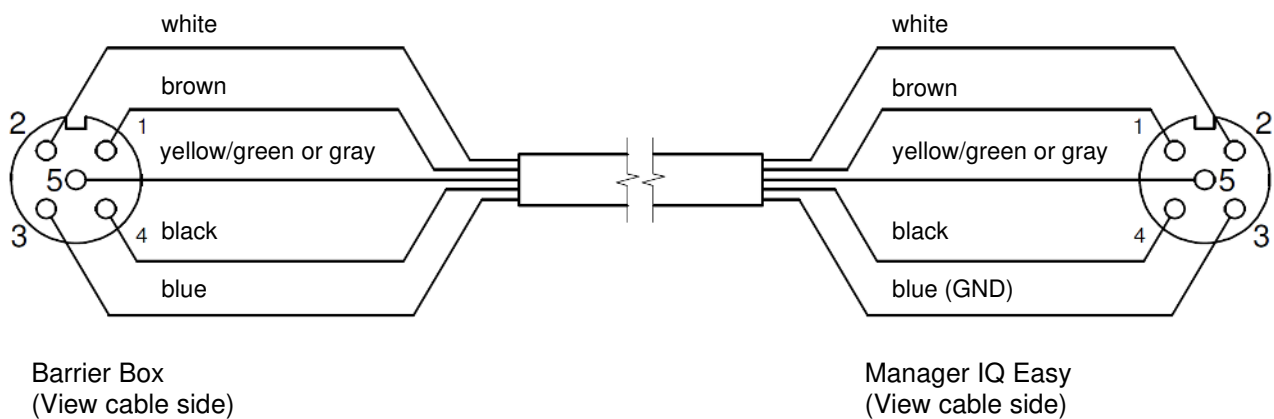

Figure 9: Wiring



Warning:

- **Connect the 4mm² earth cable form the Barrier Box to an infallible earthing system.**
- **Connect the 4mm² earth cable form the Sensor IQ Easy 2.0 EX bar to an infallible earthing system.**
- **Only the Sensor IQ Easy 2.0 EX bar should be installed in Ex-zone environments.**

6 Commissioning

Note:

- The Sensor IQ Easy 2.0 EX will not function if the sensors are covered.

6.1 Commissioning the Sensor IQ Easy 2.0 EX using the IQ Easy Platform

- When the M12 connection cable connects the Barrier Box and the Manager IQ Easy, communication will be established automatically, which is indicated by a flashing status LED and a green background colour behind the emerging sensor symbol. By default, the bar will become active after all information has been gathered by the manager. This is indicated by the background colour of the sensor display changing to green.







Please refer to the Manager IQ Easy user manual for a general explanation.



6.2 Selecting EXPERT mode for setting parameters or allowing for maintenance

In order to set parameters and carry out maintenance, you need expert user privileges. For this, a password may be required. For a detailed description, please refer to chapter 6.4 of the manual Manager IQ Easy.

Once logged in on this user level, you will remain on this level until selecting a new user level.

- Go to the main screen , select settings  and choose expert.
- Enter the password and confirm with  or return directly to the system settings page of the manager, if no password is required.
- Click on  and go to the device to check or change the parameters by clicking  behind the parameter or the desired action.
- By clicking  you return to the main screen.

6.3 Selecting mounting distance Sensor IQ Easy 2.0 EX (expert mode)

For an accurate measurement the mounting distance whereupon the Sensor IQ Easy 2.0 EX is mounted needs to be entered. By default, this is set to 50mm. If the value of this parameter departs from the actual mounting distance the measure value displayed will not correspond with the actual value.



Select the Sensor



Now the Information tab of the sensor is displayed.

Indicate that you want to change settings by choosing the settings button



The information Tab consists of several pages. With the   buttons you can scroll through the various pages.









Find the parameter Mounting distance sensor and select
Enter the mounting distance.



Confirm the value entered using . When the Sensor IQ Easy 2.0 EX is used at short distance and the Mounting distance parameter is set to a value less than 50 mm, the Web voltage parameters are displayed with extra accuracy to 3 decimal places.









6.4 Set the warning maximum level (expert mode)

The Sensor IQ Easy 2.0 EX bar will generate a warning if a segments measured value reaches the Warning set point (during warning/error delay see 6.6). This value is set to 5kV by default, but it can be easily adjusted:

- [   (n)x  "Warning maximum level" 
 slide slider or use   to go to the desired value and confirm with ].









6.4.1 Set the warning minimum level (expert mode)

The Sensor IQ Easy 2.0 EX bar will generate a warning if a segments measured value reaches the Warning set point (during warning/error delay see 6.6).It can be easily adjusted:

- [   (n)x  "Warning minimum level" 
slide slider or use   to go to the desired value and confirm with ].









6.5 Setting the alarm maximum level (expert mode)

The Sensor IQ Easy 2.0 EX will generate a alarm if a segments measured value reaches the Alarm set point (peak) (during warning/error delay see 6.6). This value is set to 10kV by default, but it can be easily adjusted:

- [   (n)x  "Alarm maximum level" 
slide slider or use   to go to the desired value and confirm with ].







6.5.1 Set the alarm minimum level (expert mode)

The Sensor IQ Easy 2.0 EX will generate a alarm if a segments measured value reaches the Alarm set point (peak) (during warning/error delay see 6.6). It can be easily adjusted:

- [   (n)x  "Alarm minimum level" 
slide slider or use   to go to the desired value and confirm with ].

6.6 Setting warning/alarm error delay (expert mode)

The Sensor IQ Easy 2.0 EX will generate a warning if a segments measured value continually exceeds the set point during warning/error delay. This value is set to 5 seconds by default, but it can be easily adjusted:

- [   (n)x  "Warning/alarm delay" 
enter the desired value and confirm with ].

6.7 Sensor IQ Easy 2.0 EX Standby & Active

By default, the bar will become active after all information has been gathered by the manager.

You can set the device in standby  or active  mode on each tab.

The status is indicated in the left upper corner by means of a colour behind the  icon:
Green = standby, blue = running, orange = warning, red = alarm.

6.8 Setting bar information parameters (expert mode)

If desired, various information parameters can be entered as required to make the different devices more recognisable.

If desired, adjust the parameters: Device name, Machine position,

These are information parameters neither the bar nor the manager will use for calculations.

- Select the information page with the parameters to be changed by:

- [, ,  (n)x  “parameter  “, enter name or value”, confirm with ]

6.9 (De)activating active segments (expert mode)

If desired, sensor segments can be activated or deactivated.

The sensor segments present are set to active by default so that they all contribute to the calculation of the average values.

If a segment is no longer in front of the object or film to be measured, this segment has to be deactivated, as the average value calculation will be incorrect otherwise.

- [, ,  (n)x  “Active segments” ]



By clicking the segment in question it will be deselected or selected, consecutively. Choose from the segments and confirm with ]

6.10 (De)activating Datalogging (expert mode)

If desired, the manager can log measurement values and data regarding the operation of the bar.

To (de)activate this data logging, the parameter Data logging has to be changed.

For detailed information on datalogging, please refer to the manual of the Manager IQ Easy.







- [, ,  (n)x  “Data logging”  select On or Off]

6.11 Switching the bar on/off remotely through the remote on/off input on the manager or using fieldbus (expert mode) (will be implemented in the software later)

If desired, the manager can be switched on and off using the remote on/off input of the Manager or by means of an instruction of the optional Fieldbus.

With this, one machine control can switch several selected devices, including this bar, on/off at the same time without having the operator to perform actions for this.

For selecting this, the Remote on/off source parameter has to be changed from Continuous to Remote or Fieldbus.

- [, , ,  (n)x  “Remote on/off source”  select Remote or Fieldbus]

7 Functional check

7.1 Functional check

The indication LED on the Barrier Box and the display of the Manager IQ Easy display information on the status of the Sensor.

Table 1, overview status indication Display Manager IQ Easy and LED on the Barrier Box

Display indication Manager IQ Easy	LED Barrier Box	Status Sensor
Blue *	Green flashing 1 Hz	Standby
Green *	Green on	Operating, no alarm, no warning.
Orange	Orange	1 active segment shows a value exceeding the warning setting
	Red flashing 1 Hz	1 active segment shows a value exceeding the measuring range
Red	Red on	1 active segment shows a value exceeding the alarm setting
	Red flashing 1 Hz	Sensor defect
	Red flashing 5 Hz	No communication with a sensor segment
Grey / no connection	Red flashing 5 Hz	No communication with Manager IQ Easy

* These are standard colours. These colours can deviate, because they can be configured differently in the Manager IQ Easy.

7.2 Functional check via the Manager IQ Easy



The display of the Manager IQ Easy displays information on the status of the Sensor IQ Easy 2.0 EX bar. Both on the main screen and on the device screens, the status of the bar can be

viewed by means of the background colour behind the icon :

Blue = standby, green = running OK, orange = warning, red = alarm.

Detailed information is provided on the Information, Graphics, Action log and Data log Tab.

7.2.1 Information tab

Using the   buttons you can scroll through the various pages.

Information regarding operation that can be found here:

- Last warning: displays the date and time from the moment the warning set point was last exceeded (during delay time at the least)
- Last warning: displays the date and time from the moment the alarm set point was last exceeded (during delay time at the least)
- Web voltage average (all) [kV]: this will display the actual average value of all active segments.
- Web voltage peak (all) [kV]: this will display the maximum negative and positive peak value of all active segments (during the last logfile refresh time).
Every time the logfile is written, this value will be reset to 0.
- Web voltage seg x [kV]: this will display the actual value of segment x.
- Web voltage peak seg x [kV]: here, the maximum negative and positive peak value of segment x will be displayed (during the last logfile refresh time).
Every time the logfile is written, this value will be reset to 0.
- If another device, e.g. a Performax Easy IQ, is connected to the Sensor, this additional device will be displayed under Paired device.
- Last Calibration date seg x. The date the segment has last been calibrated at Simco-Ion

7.2.2 Graphics tab

The Graphics tab graphically shows the operation in form of bar charts. Each segment is displayed as a vertical bar, and the last will display the average (avg) of all active segments.

- red: actual value of the measurement value
- yellow: maximum peak value during the last logfile refresh time.
Every time the logfile is written, this value will be reset to 0.

If the screen is clicked somewhere, the screen will “freeze”, and display On hold. Clicking again will display the current value.

7.2.3 Action log tab

In the Action log tab, the changed status of the bar is logged step-by-step. This is indicated with the date and time the status change has occurred. Main messages:

- HV TOO HIGH: the measured value has exceeded the alarm set point
- HV PRE WARNING: the measured value has exceeded the warning set point
- Errors Cleared: the measured value has fallen below the alarm set point.
- Warnings cleared: the measured value has fallen below the warning set point.

7.2.4 Data log tab

In the Data log tab, the average measurement value of the active segments of all available measurement data of the bar is logged at fixed times (Uavg[kV]).

If the parameter Datalogging is activated, these values will also be saved in the manager log file. The interval between logging is determined by the setting in the Manager IQ Easy. See user manual of the Manager in Chapter 6.6.3

8 Maintenance



Warning:

- **Disconnect the power supply before carrying out any work on the unit.**

8.1 Cleaning the Sensor IQ Easy 2.0 EX

- Clean the Sensor using a dry cleaning cloth. Do not use any liquids.
 - See 5.5 if demounting the Sensor is required for cleaning/replacement.

9 Faults



Warning:

- **Disconnect the power supply before carrying out any work on the unit.**
- **The electrical installation must be carried out by an electrical engineer with the relevant training and qualifications.**

Table 2, faults

Signalling	Problem	Cause	Solution
LED on the Barrier Box does not light up	No connection	No supply voltage	Positioning connection cable See 5.6
		Wiring fault	Detect fault and repair, see 5.6
LED on the Barrier Box flashes red (5 Hz)	No communication with IQ Easy platform	If connected to outputs 5 or 6: these are configured for analogue I/O	Select Serial mode in the Backplane of the Manager. See manual Manager.
		Wiring fault	Detect fault and repair, see 5.6
		Communication fault	Remove M12 Connector and reconnect.
	Communication with sensor segment has been broken	Sensor segment is not mounted properly	Mount the sensor segment again
LED on the Barrier Box lights up orange	1 segment shows a value exceeding the warning setpoint	Web voltage of the measured surface is too high	Check warning setpoint
LED on the Barrier Box lights up red continuously LED on the Barrier Box lights up red (1 Hz)	1 segment shows a value exceeding the alarm setting	Web voltage of the measured surface is too high	Check alarm set point
	1 segment shows a value exceeding the working area	Web voltage of the measured surface is too high	Check operation of ionisation equipment
	1 segment shows a malfunction	Sensor is defect	Sensor must be repaired

10 Repairs and calibration



Warning:

- **Disconnect the power supply before carrying out any work on the unit.**
- **The electrical installation and repair must be carried out by an electrical engineer with the relevant training and qualifications and in accordance with the applicable national and local regulations.**

No parts of the Sensor IQ Easy 2.0 EX can be repaired.

Simco-Ion advises you to send the Sensor IQ Easy 2.0 EX for repair to Simco-ION.

The RMA procedure can be used for returning a Simco-ION product.

An RMA number can be requested by running through the internet form procedure which can be found at <https://www.simco-ion.co.uk/repair/>

Pack the Simco-ION product properly and mention the RMA number clearly on the outside of the package.

A list of spare parts could be found below:

Item number	Part
0232000300	Segment assembly
7234004040	Dummy cover
7519000430	Dummy cover screw (2x needed)

If you have any problems or are unsure, please contact Simco-ION or your regional agent.

Calibration

Measuring segments can be calibrated. This can be done by Simco-ION, please contact Simco-ION or your regional agent for the possibility's and expenses. After confirmation, sensor segments can be shipped to Simco-ION. An RMA number is needed and can be requested by running through the internet form procedure which can be found at <https://www.simco-ion.co.uk/repair/>

They get calibrated and send back with a calibration report. The calibration interval is dependent on the application but is normally 12 months.

11 Disposal



At the end of its service life, do not throw the device away with the normal waste but hand it in at an official collection point.
By doing so, you will help to protect the environment.

Spare parts

Spare parts can be obtained from the agent in your region or from SIMCO (Nederland) B.V.

SIMCO (Nederland) B.V.
Aalsvoort 74
7241 MB Lochem - The Netherlands
Telephone+31-(0)573-288333
Email cs@simco-ion.nl
Internet <http://www.simco-ion.nl>